

# Elite Braford BREEDERS

Wide Bay Burnett Braford Promotional Group

## Heifer Sale

Saturday, 23rd March 2024

Registered, commercial & PTIC Heifers above 250kg

Gayndah Showgrounds

10.30am Start Time

42 Registered Heifers

5 Commercial Heifers

For more information contact

Agent Mark Duthie

on 0448 016 950

or Sandra Kenny on 0429 014 502

View live on Facebook



Join our Facebook Group  
Elite Braford Breeders Sale

Rabobank



# Wide Bay <sup>The</sup> Burnett Braford Group

would like to take this  
*opportunity to thank*  
the advertisers and sponsors  
of the 2024 Sale

Norco Gayndah

Rabobank

Riverina

Monto Vet

Triple S Braford Stud

Virbac Multimin

Banyula Braford Stud

Truth Designs

Zarabella Art Gallery

GDL

Australian Braford Society

Gayndah Show Society



**OUTSIDE AGENT REBATE:**

a 2% rebate will be paid to outside agents who have introduced their buyers in writing to GDL Dalby prior to the commencement of the sale, accompany their buyers/s to the sale and settle on their behalf within 7 days. Vendors having an outside agent are not eligible.

**WIDE BAY BURNETT BRAFORD ELITE  
FUTURE BREEDERS SALE**

**GAYNDAH SHOWGROUNDS,  
SPENCER STREET GAYNDAH QLD**

**42 Registered Heifers**

**5 Commercial Heifers**

**FOR FURTHER INFORMATION  
PLEASE CONTACT**

**Mark Duthie**

**Mobile: 0448 016 950**

**GDL Dalby**



# Vendors

# Vendors

**Vendor**

**Stud**

**Lot Numbers**

## *Kelvin and Jacinta Dawson*

Greenvale Braford's

620 Tableland Road

TAUNTON QLD 4674

Property Number: QDMV0024

ABN: 24 876 878 717

Phone: 0437 648 176

**Greenvale**

**8-9, 32-33**

## *Stuart and Janelle Dingle*

Chasewater Braford's

5096 Gayndah-Mt Perry Road

MT PERRY QLD 4671

Property Number: QCPE0110

ABN: 82 442 129 939

Phone: 4156 3937 / 0488 025 099

**Chasewater**

**29-30**

## *Donovan Family*

Ashby Braford's

Donovan Family Partnership

583 Lyndley Lane

JIMBOUR QLD 4406

Property Number: QCWB0110

ABN: 87 533 968 194

Phone: 0429 175 439

**Ashby**

**37-38**

# Vendors

**Vendor**

**Stud**

**Lot Numbers**

## *Connor & Arlo Duthie*

Pinegroves

366 Mahoneys Road

IRVINGDALE QLD

Property Number: QARA1611

ABN: 60 208 769 235

Phone: 0448 016 950

**Duthie**

**46**

## *Galloway Family*

Ascot Neimen Braford's

Ascot

489 Barfield Road

BANANA QLD

Property Number: QCBM0728

ABN: 58 329 421 081

Phone: 0407 499 006 / 0417 640 897

**Ascot & Neimen**

**10-12**

## *Robert and Lesette Hoffmann*

Downfall Creek Braford's

Silva

GULUGUBA QLD 4418

Property Number: QKTR0531

ABN: 87 519 373 102

Phone: 4628 2284 / 0428 282 284

**Downfall Creek**

**24-27**

# Vendors

**Vendor**

**Stud**

**Lot Numbers**

*Malcolm and Sandra Kenny*

Abernethy Braford's

2286 Wigton Road

GAYNDAH QLD 4625

**Abernethy**

**43-45**

Property Number: QIGD0222

ABN: 91 954 262 406

Phone: 0456 681 644 / 0429 014 502

*Russell and Donna Kenny*

Harriett Valley Braford's

PO Box 210

GAYNDAH QLD 4625

**Harriett Valley**

**15-23**

Property Number: QKGD0429

ABN: 51 970 687 601

Phone: 0427 531 617 / 0427 416 113

*Knauth Family*

Nungil Braford's

16 Joann Court

Oakey QLD 4401

**Nungil**

**39-40**

Property Number: QCRA0479

ABN: 17 544 733 455

Phone: 0427 733 151

# Vendors

**Vendor**

**Stud**

**Lot Numbers**

## *Robert Kliese*

Teviot Hills Braford's

344 Mutdapilly Churchbank Weir Road  
MUTDAPILLY QLD 4307

**Teviot Hills**

**30-31**

Property Number: QEIW1282

ABN: 87 858 858 336

Phone: 0438 635 903

## *Cameron and Sarah Bennett*

Little Valley Grazing Co

Little Valley Braford's

545 Stratheden Road

Stratheden CASINO NSW 2470

**Little Valley**

**5-6, 21-23**

Property Number: NI121503

ABN: 28 148 989 261

Phone: 0431 375 625

## *Mc Namara Family*

Strathgyle Braford's

3171 Macalister-Bell Road

BELL QLD 4408

**Strathgyle**

**34-35**

Property Number: QEWB0843

ABN: 85 238 129 919

Phone: 0439 755 897



# Vendors

**Vendor**

**Stud**

**Lot Numbers**

## *Mc Namara Partnership*

MCN Braford's

"The Glen"

847 Spring Flat Road

BEL QLD 4408

Property Number: QGWB0521

ABN: 90 228 132 549

Phone: 0438 335 765

**MCN**

**13-14**

## *C & S Moger*

Triple S Braford's

Weowner

538 Montrose Road

CAPELLA QLD 4723

Property Number: QFPD0276

ABN: 91 554 141 743

Phone: 0427 170 519

**Triple S Braford's**

**4, 36**

## *Rhonda Ryan*

Banyula Braford's

PO BOX 736

1715 Lilyvale Road

EMERALD QLD 4720

Property Number: QBPD0252

ABN: 28 301 208 656

Phone: 0429 631 390

**Banyula**

**1, 47**

# Vendors

**Vendor**

**Stud**

**Lot Numbers**

*GCLJ & EL Webster*

Goomora Braford's

274 Websters Road

GOOMBOORIAN via GYMPIE QLD 4570

Property Number: QIWG0514

ABN: 47 406 020 901

Phone: 0409 865 128

**Goomora**

**2-3, 41-42**



**AUSTRALIAN BRAFOR'D SOCIETY**

**2024 National Braford Sale**

**Monday, 9th September 2024 CQLX Gracemere**



**[www.braford.org.au](http://www.braford.org.au)**

# REGISTERED heifers

**Lots 1-42**

*All animals have been pre-treated for ticks*

# Lot 1 BANYULA TULIP 1726 (P) P121840



**NOTES:** Pompes free. Impeccable temperament. Halter broken, shown by 7yr old girl. Had an early calf, which was weaned in January. Served by Strathgyle Jimmy on 21/10/23, due on or about 30/07/24. Preg test results at sale. Sire verified. Gene Tested HPC. (Polled/scurred)

*Pedigree*

**DOB:** 21/07/2021

**BRAND:** SCRIPT B  
OVER SCROLL DOT

### Vaccinations

- 3-day sickness
- 5 in 1
- 7 in 1
- 3 Germ Blood

BANYULA TULIP 1726 (P) P121840

Sire: DOWNFALL CREEK  
GARRY GRANT (P) P119495

Sire: DONRINDA J124  
JINDABYNE (P) P115122

Dam: DOWNFALL CREEK  
319 (H) P113086

Dam: BANYULA TULIP 1641  
(P) P117916

Sire: BANYULA BIRETTA  
1448 (S) P111799

Dam: BANYULA TULIP 1565  
(P) P114196

# Lot 2 GOOMORA JOSIE A746 (P) P121582



**NOTES:** Pompes and Pesti Virus free. Sire verified. Gene tested PP. Tenderness 4. PTIC to Teviot Hills 762.

## Pedigree

**DOB:** 20/06/2021

**BRAND:** MW  
INVERTED TRIANGLE

## Vaccinations

- 3-day sickness
- 5 in 1
- 7 in 1
- 3 Germ Blood

GOOMORA JOSIE A746 (P) P121582

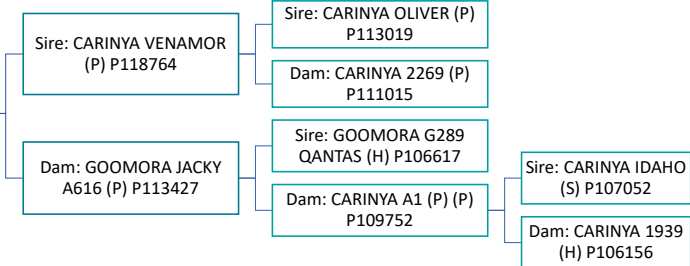

**Purchaser:**

\$



# Lot 3 GOOMORA KATH A751 (P) P121584



**NOTES:** Pompes and Pestie Virus free. Sire verified. Gene tested PP. Tenderness 3. PTIC to Teviot Hill 762.

*Pedigree*

**DOB:** 17/08/2021

**BRAND:** MW INVERTED TRIANGLE

## Vaccinations

- 3-day sickness
- 5 in 1
- 7 in 1
- 3 Germ Blood

GOOMORA KATH A751 (P) P121584

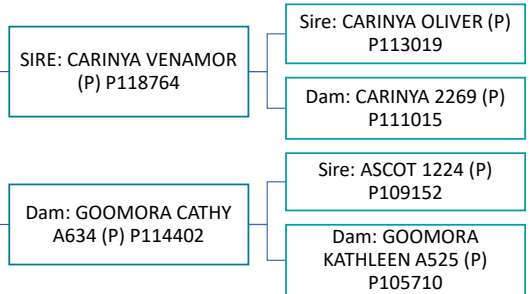

Grow With Us

Meet Your Local  
Bundaberg Team



**Grow with the bank  
founded by farmers for farmers**

Our agri-banking experts live and work where you do and are passionate about the future of rural communities. That's why season after season, year after year, we'll be here to help you grow.

**If you'd like to grow with Rabobank**

Call Peter on 0428 101 471, Wendy on 0459 842 947 or the team on 4130 0952



# Lot 4 TRIPLE S IDI 194 (P) P122176



**NOTES:** Pompes free. Homozygous polled heifer. PTIC (AI) to Winvic 3579 PP. Dam 5 calves from 3 joins, average calving interval 357 days. GDam classified cow 7 calves from 7 joins, average calving interval 377 days.

*Pedigree*

**DOB:** 28/10/2021

**BRAND:** C2 LAZY S

## Vaccinations

- 3-day sickness
- 5 in 1
- 7 in 1
- 3 Germ Blood

TRIPLE S IDI 194 (P) P122176

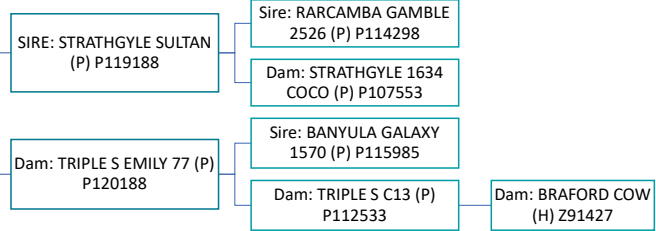



# Lot 5 LITTLE VALLEY MISS SHER 3533 (P) P121633



**NOTES:** Pompes and Pesti Virus free. PTIC status to be announced on sale day.  
Running with bull.

*Pedigree*

**DOB:** 17/10/2021

**BRAND:** W IN DIAMOND  
UPPER HALF CIRCLE

### Vaccinations

- 3-day sickness
- 5 in 1
- 7 in 1
- 3 Germ Blood

LITTLE VALLEY MISS SHER 3533 (P) P121633

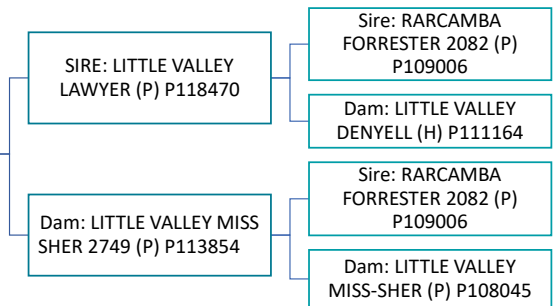

**Purchaser:**

\$

# Lot 6 LITTLE VALLEY OLIVIA 3517 (P) P121604



**NOTES:** Pompes and Pesti Virus free. PTIC status to be announced on sale day. Running with bull. Sire verified.

**DOB:** 24/11/2021

**BRAND:** W IN DIAMOND  
UPPER HALF CIRCLE

## Vaccinations

- 3-day sickness
- 5 in 1
- 7 in 1
- 3 Germ Blood

*Pedigree*

LITTLE VALLEY OLIVIA 3517 (P) P121604

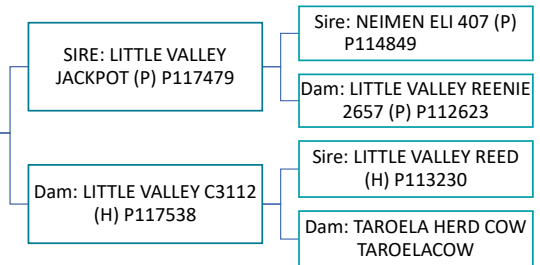

# Lot 7 LITTLE VALLEY RAE 3513 (P) P121641



**NOTES:** Pompes and Pesti Virus free. PTIC status to be announced on sale day.  
Running with bull. Sire verified.

*Pedigree*

**DOB:** 2/9/2021

**BRAND:** W IN IAMOND  
UPPER HALF CIRCLE

### Vaccinations

- 3-day sickness
- 5 in 1
- 7 in 1
- 3 Germ Blood

LITTLE VALLEY RAE 3513 (P) P121641

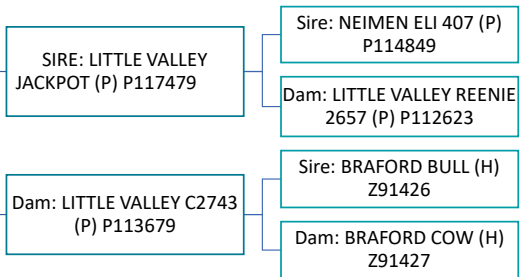

**Purchaser:**

\$

# Lot 8 GREENVALE 44 (P) P122647



**NOTES:** Pompes free. Has been running with Greenvale 23 Stud Bull. Sire verified. Heterozygous Poll. Tenderness 6.

*Pedigree*

**DOB:** 13/11/2021

**BRAND:** K SPADE X

## Vaccinations

- 3-day sickness
- 5 in 1
- 7 in 1
- 3 Germ Blood

GREENVALE 44 (P) P122647

SIRE: LITTLE VALLEY  
KENWORTH (P) P119586

Sire: NEIMEN ELI 407 (P)  
P114849

Dam: LITTLE VALLEY  
SHANIKA 2757 (P) P115942

Dam: GREENVALE C13 (P)  
P119754

Sire: HALCYON STUD BULL

Dam: HALCYON STUD  
COW12



# Lot 9 GREENVALE 42 (P) P122539



**NOTES:** Pompes free. Has been running with Greenvale 23 Stud Bull. Sire verified. Homozygous Poll PP. Tenderness 6.

*Pedigree*

**DOB:** 14/10/2021

**BRAND:** K SPADE X

## Vaccinations

- 3-day sickness
- 5 in 1
- 7 in 1
- 3 Germ Blood

GREENVALE 42 (P) P122539

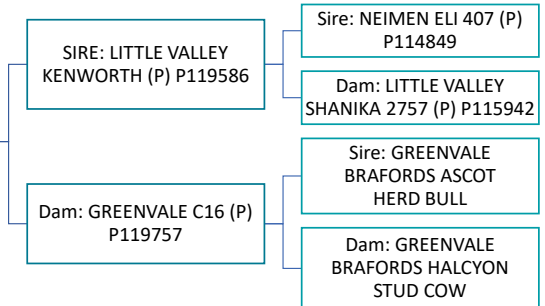

**Purchaser:**

\$

# Lot 10 ASCOT BETH 3216 (P) P123249



**NOTES:** Pompes free. Bull Calf DOB 23/11/2023 (4 months sale day) by Herd Bull. Will be sold as a commercial animal. Heifer Beth 3216 running with bull since early February 2024.

*Pedigree*

**DOB:** 13/12/2021

**BRAND:** IGL (SCRIPT)

### Vaccinations

- 3-day sickness
- 5 in 1
- 7 in 1
- 3 Germ Blood

ASCOT BETH 3216 (P) P123249

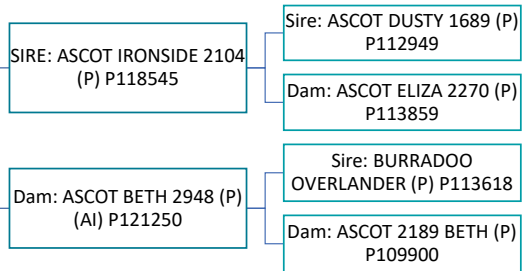

# Lot 11 ASCOT ROYCIIE 3223 (P) P123250



**NOTES:** Pompes free. Heifer calf DOB 8/12/23 (3.5 months sale day). Sire is a Herd Bull. Sold as a commercial animal. Roycie 3223 has been running with a bull since early February 2024.

*Pedigree* ↘

**DOB:** 11/2/2022

**BRAND:** IGL (SCRIPT)

### Vaccinations

- 3-day sickness
- 5 in 1
- 7 in 1
- 3 Germ Blood

ASCOT ROYCIIE 3223 (P) P123250

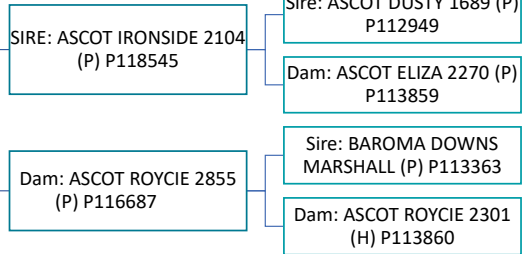

**Purchaser:**

\$



# Lot 12 ASCOT MARION 3215 (P) P123248



**NOTES:** Pompes free. Hiefer calf DOB 20/12/2023 (3 months sale day). The calf is by a Herd Bull and is sold as a commercial animal. Marion 3215 has been running with a bull since early February 2024.

*Pedigree*

**DOB:** 11/02/2022

**BRAND:** IGL (SCRIPT)

### Vaccinations

- 3-day sickness
- 5 in 1
- 7 in 1
- 3 Germ Blood

ASCOT MARION 3215 (P) P123248

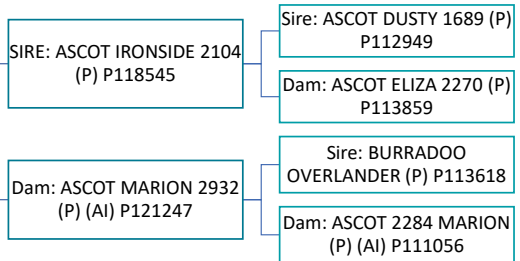



# Lot 13 MCN FAWN (P) P123372



**NOTES:** Pompes and Pesti Virus free. Sire verified. Very quiet nature heifer.

**DOB:** 08/08/2022

**BRAND:** N7K

## Vaccinations

- 3-day sickness
- 5 in 1
- 7 in 1
- 3 Germ Blood

*Pedigree*

MCN FAWN (P) P123372

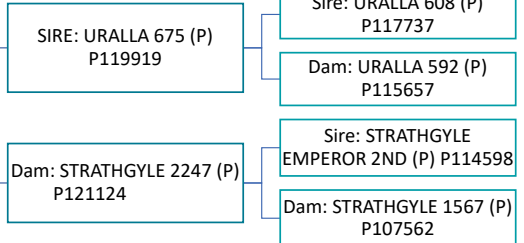

**Purchaser:**

\$

# Lot 14 MCN AMBER (P) P123373



**NOTES:** Pompes and Pesti Virus free. Homozygous Poll (PP). Sire verified. Very quiet nature heifer.

**DOB:** 06/08/2022

**BRAND:** N7K

## Vaccinations

- 3-day sickness
- 5 in 1
- 7 in 1
- 3 Germ Blood

*Pedigree*

MCN AMBER (P) P123373

SIRE: ASCOT ICON 2071 (S)  
P118887

Sire: ASCOT DUSTY 1689 (P)  
P112949

Dam: ASCOT BEAUTY 2384  
(H) P117212

Dam: URALLA 643 (P)  
P118188

Sire: HARRIETT VALLEY  
MYLES (P) P113903

Dam: URALLA 405 (P)  
P109816

Lot 15

# HARRIETT VALLEY XANDRA (P) P123236



**NOTES:** Pompes free. Sire verified.

**DOB:** 1/03/2022

**BRAND:** E OVER  
HALF CIRCLE

### Vaccinations

- 3-day sickness
- 5 in 1
- 7 in 1
- 3 Germ Blood

*Pedigree*

HARRIETT VALLEY XANDRA (P) P123236

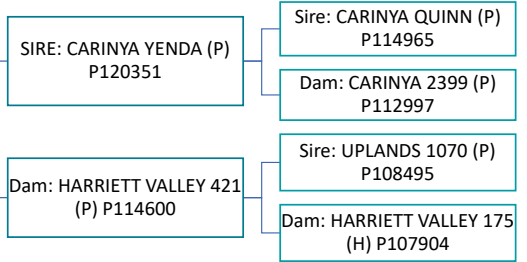

**Purchaser:**

\$

# Lot 16 HARRIETT VALLEY XIA (P) P123241



**NOTES:** Pompes free. Sire verified.

**DOB:** 12/3/2023

**BRAND:** LAZY E OVER WINGS DOT

## Vaccinations

- 3-day sickness
- 5 in 1
- 7 in 1
- 3 Germ Blood

*Pedigree*

HARRIETT VALLEY XIA (P) P123241

SIRE: LITTLE VALLEY RICHARD 2976 (P) P116777

Sire: LITTLE VALLEY ACTON (P) P114609

Dam: LITTLE VALLEY MISS SHER 2749 (P) P113854

Dam: HARRIETT VALLEY 648 (H) P121142

Sire: ASCOT GOUGH 1782 (P) P116254

Dam: HARRIETT VALLEY C629 (P) P119958



# Lot 17 HARRIETT VALLEY XANTHIA (P) P123239



**NOTES:** Pompes free. Sire verified.

**DOB:** 12/3/2023

**BRAND:** LAZY E OVER WINGS DOT

## Vaccinations

- 3-day sickness
- 5 in 1
- 7 in 1
- 3 Germ Blood

*Pedigree*

HARRIETT VALLEY XANTHIA (P) P123239

SIRE: LITTLE VALLEY RICHARD 2976 (P) P116777

Sire: LITTLE VALLEY ACTON (P) P114609

Dam: LITTLE VALLEY MISS SHER 2749 (P) P113854

Dam: HARRIETT VALLEY 458 (P) (AI) P118328

Sire: LITTLE VALLEY LAWMAN (H) P112067

Dam: HARRIETT VALLEY 382 (H) P112300

**Purchaser:**

\$



# Get more beef for your buck

- ✓ **Australian made**
- ✓ **Nutritionally balanced**
- ✓ **Custom mixed**

Enhance your herd's growth and performance with Australia's trusted manufacturer and supplier of premier stock feeds. Find the right nutritional solution for your cattle with our range of expertly formulated stock feeds and supplements.

How can Riverina Stockfeeds assist your feeding programs?  
**Learn more** →



[riverina.com.au](http://riverina.com.au)



Your partner of choice in feeding the world.



# Lot 18 HARRIETT VALLEY XARIA (H) P123240



**NOTES:** Pompes Free. Sire Verified.

**DOB:** 12/3/2023

**BRAND:** LAZY E OVER WINGS DOT

## Vaccinations

- 3-day sickness
- 5 in 1
- 7 in 1
- 3 Germ Blood

*Pedigree*

HARRIETT VALLEY XARIA (H) P123240

SIRE: LITTLE VALLEY RICHARD 2976 (P) P116777

Sire: LITTLE VALLEY ACTON (P) P114609

Dam: LITTLE VALLEY MISS SHER 2749 (P) P113854

Dam: HARRIETT VALLEY 478 (H) P118330

Sire: HARRIETT VALLEY ARRAN 2259 (P) P109965

Dam: ALBERTA AMY 1266 (H) P108324

**Purchaser:**

\$



# Lot 19 HARRIETT VALLEY XAMIRA (P) P123238



**NOTES:** Pompes free. Sire verified.

**DOB:** 12/3/2023

**BRAND:** LAZY E OVER WINGS DOT

## Vaccinations

- 3-day sickness
- 5 in 1
- 7 in 1
- 3 Germ Blood

*Pedigree*

HARRIETT VALLEY XAMIRA (P) P123238

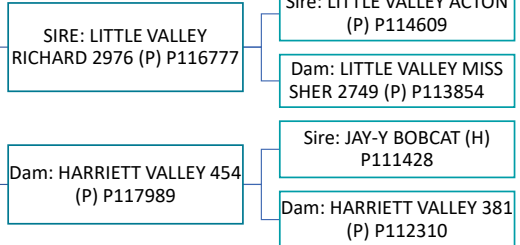



# Lot 20 HARRIETT VALLEY Xyla (P) P123238



**NOTES:** Pompes free. Sire verified.

**DOB:** 12/3/2023

**BRAND:** LAZY E OVER WINGS DOT

## Vaccinations

- 3-day sickness
- 5 in 1
- 7 in 1
- 3 Germ Blood

*Pedigree*

HARRIETT VALLEY Xyla (P) P123237

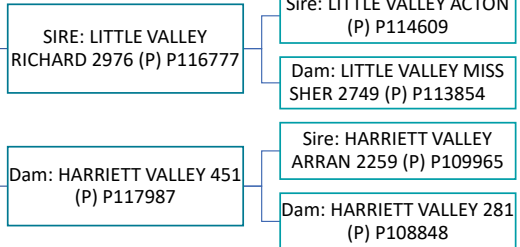

**Purchaser:**

\$

# Lot 21 LITTLE VALLEY DOWNSLY 3644 (P) P123314



**NOTES:** Pompes and Pesti Virus free. Sire verified.

**DOB:** 25/2/2023

**BRAND:** W IN DIAMOND  
UPPER HALF CIRCLE

## Vaccinations

- 3-day sickness
- 5 in 1
- 7 in 1
- 3 Germ Blood

*Pedigree*

LITTLE VALLEY DOWNSLY 3644 (P) P123314

SIRE: LITTLE VALLEY NACHO  
(P) P120018

Dam: LITTLE VALLEY  
DOWNSLY 3386 (P)  
P120753

Sire: LITTLE VALLEY LARRY  
2973 (P) P116779

Dam: BURRADOO 2163 (P)  
P114168

Sire: VARYKINO JIMMY (P)  
P114641

Dam: LITTLE VALLEY  
DOWNSLY 2951 (P)  
P119537

# Lot 22 LITTLE VALLEY KIRA ANN 3646 (P) P123311



**NOTES:** Pompes and Pesti Virus free. Sire verified. Homozygous Poll (PP).

**BORN:** 28/01/2023

**BRAND:** W IN DIAMOND  
UPPER HALF CIRCLE

## Vaccinations

- 3-day sickness
- 5 in 1
- 7 in 1
- 3 Germ Blood

*Pedigree*

LITTLE VALLEY KIRA ANN 3646 (P) P123311

SIRE: LITTLE VALLEY NACHO  
(P) P120018

Sire: LITTLE VALLEY LARRY  
2973 (P) P116779

Dam: BURRADOO 2163 (P)  
P114168

Dam: LITTLE VALLEY KIRA  
ANN 3363 (P) P120757

Sire: LITTLE VALLEY  
JACKPOT (P) P117479

Dam: LITTLE VALLEY KIRA  
ANN 2735 (H) P113839

**Purchaser:**

\$

# Lot 23 LITTLE VALLEY SCARLETT 3645 (P) P123313



**NOTES:** Pompes and Pesti Virus free. Sire verified.

**BORN:** 17/02/2023

**BRAND:** W IN DIAMOND  
UPPER HALF CIRCLE

## Vaccinations

- 3-day sickness
- 5 in 1
- 7 in 1
- 3 Germ Blood

*Pedigree*

LITTLE VALLEY SCARLETT 3645 (P) P123313

SIRE: LITTLE VALLEY NACHO  
(P) P120018

Dam: LITTLE VALLEY  
SCARLETT (P) P120746

Sire: LITTLE VALLEY LARRY  
2973 (P) P116779

Dam: BURRADOO 2163 (P)  
P114168

Sire: LITTLE VALLEY LARRY  
2973 (P) P116779

Dam: LITTLE VALLEY C3106  
(H) P117550



# Lot 24 DOWNFALL CREEK LANA 460 (P) P122308



**NOTES:** Pompes free. Unjoined.

**BORN:** 2/8/2022

**BRAND:** RDH OFF SIDE RUMP

## Vaccinations

- 3-day sickness
- 5 in 1
- 7 in 1
- 3 Germ Blood

*Pedigree*

DOWNFALL CREEK LANA 460 (P) P122308

SIRE: BAROMA DOWNS TANGO (P) P118607

Sire: ASCOT COCOA 1585 (P) P113445

Dam: BAROMA DOWNS 339 (P) P114389

Dam: DOWNFALL CREEK C343 (P) P114205

Sire: CARINYA KANE (P) P109310

Dam: BRAFORD COW (H) Z91427

**Purchaser:**

\$

# **Norco Rural** **Gayndah**

**59 Dalgangal Road - Ph: 07 4140 8542**

***We have everything you  
need for your farm or yard.***

**Animal Health  
Fencing  
Produce and Fodder  
Ag Chemicals  
Pet Supplies  
Garden  
Seeds and Fert  
And so much more...**

***Because there's a  
farmer in all of us***

**Norco - an Australian, farmer owned  
dairy co-operative since 1895**



# Lot 25 DOWNFALL CREEK 464 (P) P122307



**NOTES:** Pompes free. Unjoined.

**BORN:** 15/10/2022

**BRAND:** RDH OFF SIDE RUMP

## Vaccinations

- 3-day sickness
- 5 in 1
- 7 in 1
- 3 Germ Blood

*Pedigree*

DOWNFALL CREEK 464 (P) P122307

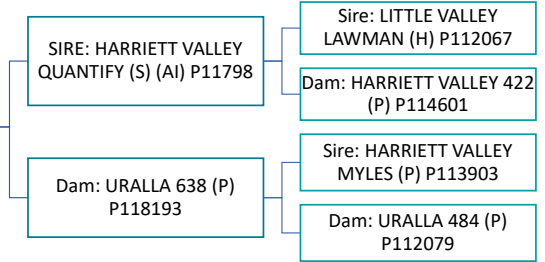

**Purchaser:**

\$

# Lot 26 DOWNFALL CREEK 469 (P) P122301



**NOTES:** Pompes free. Unjoined.

**BORN:** 17/12/2022

**BRAND:** RDH OFF SIDE RUMP

## Vaccinations

- 3-day sickness
- 5 in 1
- 7 in 1
- 3 Germ Blood

*Pedigree*

DOWNFALL CREEK 469 (P) P122301

SIRE: HARRIETT VALLEY  
QUANTIFY (S) (AI) P117984

Sire: LITTLE VALLEY  
LAWMAN (H) P112067

Dam: HARRIETT VALLEY 422  
(P) P114601

Dam: DOWNFALL CREEK  
412 (P) P117957

Sire: DONRINDA J124  
JINDABYNE (P) P115122

Dam: DOWNFALL CREEK  
316 (P) P113081



# Lot 27 DOWNFALL CREEK 461 (P) P122298



**NOTES:** Pompes free. Unjoined.

**BORN:** 15/10/2022

**BRAND:** RDH OFF SIDE RUMP

## Vaccinations

- 3-day sickness
- 5 in 1
- 7 in 1
- 3 Germ Blood

*Pedigree*

DOWNFALL CREEK 461 (P) P122298

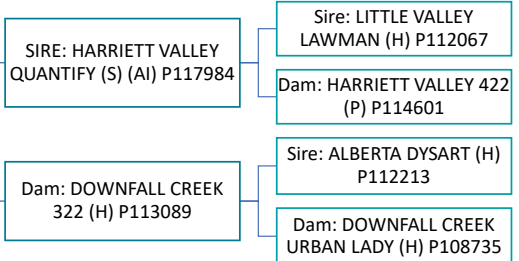

**Purchaser:**

\$

# Lot 28 CHASEWATER CLAIRE (P) P123271



**NOTES:** Pompes free. Handled with dogs and horses.

**BORN:** 5/6/2022

**BRAND:** TENT 7 T

## Vaccinations

- 3-day sickness
- 5 in 1
- 7 in 1
- 3 Germ Blood

*Pedigree*

CHASEWATER CLAIRE (P) P123271

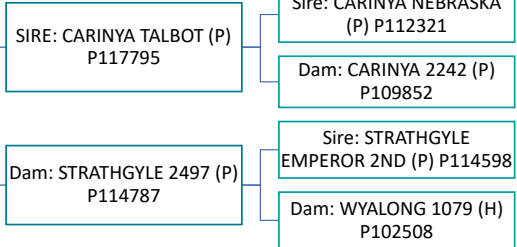

# Lot 29 CHASEWATER CAMILLE (P) P123272



**NOTES:** Pompes free. Handled with dogs, bikes and horses.

**BORN:** 1/9/2022

**BRAND:** TENT 7 T

## Vaccinations

- 3-day sickness
- 5 in 1
- 7 in 1
- 3 Germ Blood

*Pedigree*

HASEWATER CAMILLE (P) P123272

SIRE: CARINYA YANDILLA (P)  
P120349

Dam: CHASEWATER 022 (H)  
P119189

Sire: CARINYA SORENSON  
(P) P116762

Dam: CARINYA 2596 (P)  
P114950

Sire: STRATHGYLE SANDY  
(H) P116075

Dam: CHASEWATER C3 (H)  
P116474

**Purchaser:**

\$





# CUTTING EDGE PERFORMANCE, EVOLVED

Now delivers 29%\* more trace minerals

GET YOUR CATTLE PERFORMANCE READY WITH  
**MULTIMIN® EVOLUTION**

\*29% more minerals compared to the market leader [Multimin for Cattle]

## MONTO



### VETERINARY GROUP

Our vets are BULLCHECK and PREGCHECK accredited with the Australian Cattle Veterinarian Association and can undertake all of your bull testing and pregnancy testing requirements for stud, sale and commercial herds.

Our team have a true passion for all aspects of livestock production from the biggest operation to the smallest farm.

We're open 5 days a week, plus our after hours service provides 24/7 assistance in emergencies.



AUSTRALIAN  
CATTLE  
VETERINARIANS

[www.montovet.com.au](http://www.montovet.com.au)



**Monto Clinic:** 8 Lister Street, MONTO QLD 4630 **Ph:** (07) 4166 1285  
**Mundubbera Clinic:** 5 Willson Avenue, MUNDUBBERA QLD 4626 **Ph:** (07) 4165 4386

# Lot 30 TEVIOT HILLS COURTNEY (P) P123199



**NOTES:** Pompes and Pesti Virus free.

**BORN:** 20/10/2022

**BRAND:** KAR

## Vaccinations

- 3-day sickness
- 5 in 1
- 7 in 1
- 3 Germ Blood

*Pedigree*

TEVIOT HILLS COURTNEY (P) P123199

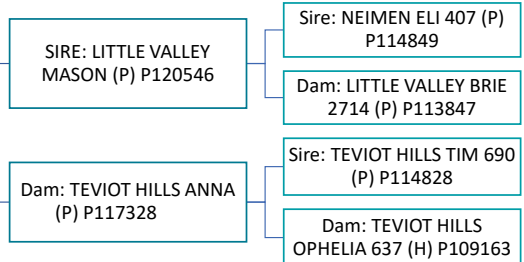

**Purchaser:**

\$



# Lot 31 TEVIOT HILLS CHRIS (P) P123200



**NOTES:** Pompes and Pesti Virus free.

**BORN:** 9/09/2022

**BRAND:** KAR

## Vaccinations

- 3-day sickness
- 5 in 1
- 7 in 1
- 3 Germ Blood

*Pedigree* ↘

TEVIOT HILLS CHRIS (P) P123200

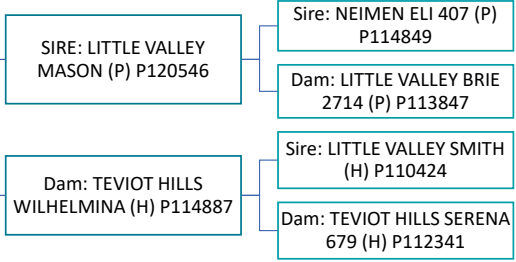

# Lot 32 GREENVALE 48 (P) P122538



**NOTES:** Pompes free. Has been running with Greenvale 23 Stud Bull. Sire verified. Homozygous Poll PP. Tenderness 5.

**BORN:** 19/05/2022

**BRAND:** K SPADE X

## Vaccinations

- 3-day sickness
- 5 in 1
- 7 in 1
- 3 Germ Blood

*Pedigree*

GREENVALE 48 (P) P122538

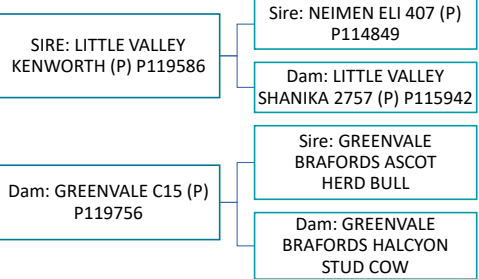

**Purchaser:**

\$

# Lot 33 GREENVALE 45 (P) P122541



**NOTES:** Pompes free. Has been running with Greenvale 23 Stud Bull. Sire verified. Heterozygous Poll. Tenderness 10.

**BORN:** 30/05/2022

**BRAND:** K SPADE X

## Vaccinations

- 3-day sickness
- 5 in 1
- 7 in 1
- 3 Germ Blood

*Pedigree*

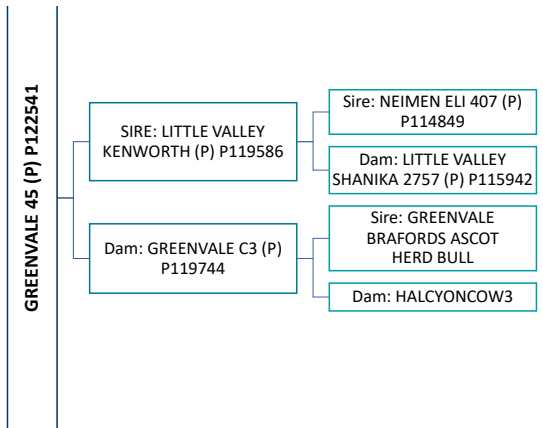



# Lot 34 STRATHGYLE SASHA (P) P123298



**NOTES:** Pompes free. Pesti Virus tested negative. Genomics tested. Sire verified. Tenderness 7. PP.

*Pedigree*

**BORN:** 26/12/2022

**BRAND:** L DIAMOND U

## Vaccinations

- 3-day sickness
- 5 in 1
- 7 in 1
- 3 Germ Blood

STRATHGYLE SASHA (P) P123298

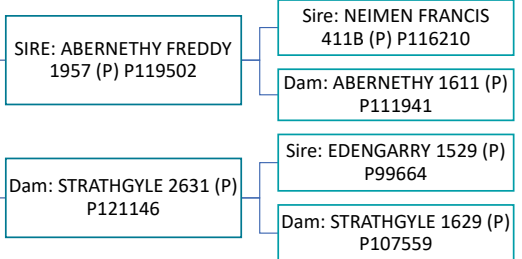

**Purchaser:**

\$

# Lot 35 STRATHGYLE OPAL (P) P123299



**NOTES:** Pompes free. Pesti Virus tested negative. Genomics tested. Sire verified. Tenderness 7.

*Pedigree*

**BORN:** 28/1/2023

**BRAND:** L DIAMOND U

## Vaccinations

- 3-day sickness
- 5 in 1
- 7 in 1
- 3 Germ Blood

STRATHGYLE OPAL (P) P123299

SIRE: ABERNETHY FREDDY  
1957 (P) P119502

Sire: NEIMEN FRANCIS  
411B (P) P116210

Dam: ABERNETHY 1611 (P)  
P111941

Dam: STRATHGYLE 2810 (P)  
P121131

Sire: JAY-Y SMOOGER (S)  
P114120

Dam: STRATHGYLE JENNA  
(H) P110329



# Zarabella's Art Gallery



zarabellasartgallery



Zarabella Bambling  
Artist



# GDL

A NUTRIEN AG SOLUTIONS PARTNER



## Mark Duthie

*“Local People, National Connections”*

0448 016 950

# Lot 36 TRIPLE S JAY-JAY 232 (P) P122550



**NOTES:** Pompes free. Homozygous polled heifer. PTIC to Triple S Bull sired by Strathgyle Guess Who. Dam 4 calves from 4 joins, average calving interval 365 days. GDam classified cow 7 calves from 7 joins, average calving interval 364 days.

*Pedigree*

**BORN:** 10/9/2022

**BRAND:** C2 LAZY S

### Vaccinations

- 3-day sickness
- 5 in 1
- 7 in 1
- 3 Germ Blood

TRIPLE S JAY-JAY 232 (P) P122550

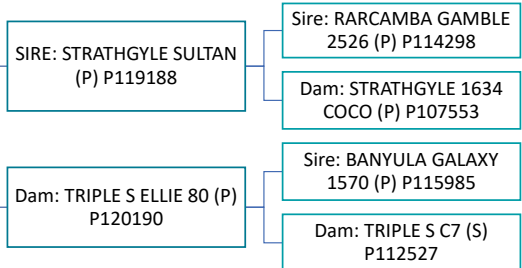

# Lots 37 ASHBY 1259 (P) P123243



**NOTES:** Pompes and Pesti Virus free. Unjoined. Dam is one of the quietest cows in the herd.

*Pedigree*

**BORN:** 10/12/2022

**BRAND:** E OVER HALF  
MOON DOT

### Vaccinations

- 3-day sickness
- 5 in 1
- 7 in 1
- 3 Germ Blood

ASHBY 1259 (P) P123243

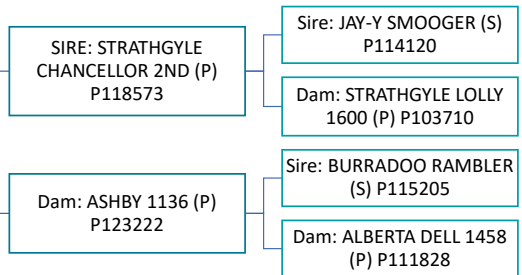

**Purchaser:**

\$

# Lot 38 ASHBY 1290 (P) P123244



**NOTES:** Pompes and Pesti Virus free. Unjoined.

*Pedigree*

**BORN:** 12/12/2022

**BRAND:** E OVER HALF  
MOON DOT

### Vaccinations

- 3-day sickness
- 5 in 1
- 7 in 1
- 3 Germ Blood

ASHBY 1290 (P) P123244

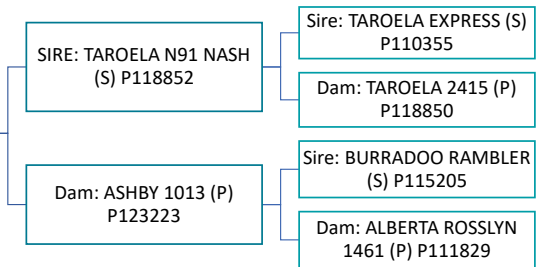



# Lot 39 NUNGIL FORTRESS (P) P122374



**NOTES:** Pompes and Pesti Virus free.

## Pedigree

**BORN:** 23/09/22

**BRAND:** CK4

## Vaccinations

- 3-day sickness
- 5 in 1
- 7 in 1
- 3 Germ Blood

NUNGIL FORTRESS (P) P122374

SIRE: CARINYA YORKSTON  
(P) P119338

Dam: COOGRALI QUE 92 (P)  
P114039

Sire: CARINYA PERRETT (P)  
P114944

Dam: CARINYA 2401 (P)  
P112998

Sire: ASCOT 1344 (P)  
P110580

Dam: COOGRALI YASSILIKI  
972 (P) P107875

Dam: COOGRALI  
ALICE (H) P101453

**Purchaser:**

\$



# Lot 40 NUNGIL FIONA (H) P122370



**NOTES:** Pompes and Pesti Virus free.

**BORN:** 22/10/22

**BRAND:** CK4

## Vaccinations

- 3-day sickness
- 5 in 1
- 7 in 1
- 3 Germ Blood

*Pedigree*

NUNGIL FIONA (H) P122370

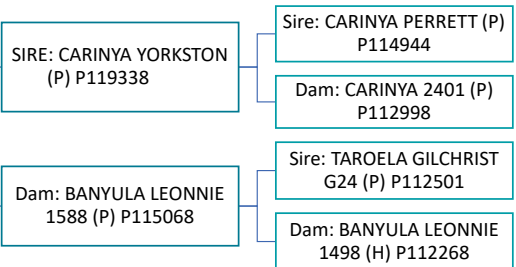

# Lot 41 GOOMORA MAHALIA A767 (P) P122591



**NOTES:** Pompes and Pesti Virus free. Sire verified. Gene tested PP. Tenderness 6.

*Pedigree*

**BORN:** 17/07/2022

**BRAND:** MW INVERTED TRIANGLE

*Vaccinations*

- 3-day sickness
- 5 in 1
- 7 in 1
- 3 Germ Blood

GOOMORA MAHALIA A767 (P) P122591

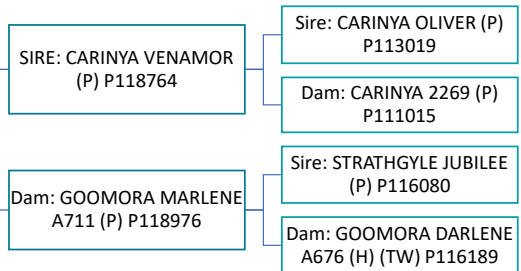

**Purchaser:**

\$

# Lot 42 GOOMORA MANDY A766 (P) P122583



**NOTES:** Pompes and Pesti Virus free. Sire verified. Gene tested HP. Tenderness 4.

*Pedigree*

**DOB:** 22/07/2022

**BRAND:** MW  
INVERTED TRIANGLE

### Vaccinations

- 3-day sickness
- 5 in 1
- 7 in 1
- 3 Germ Blood

GOOMORA MANDY A766 (P) P122583

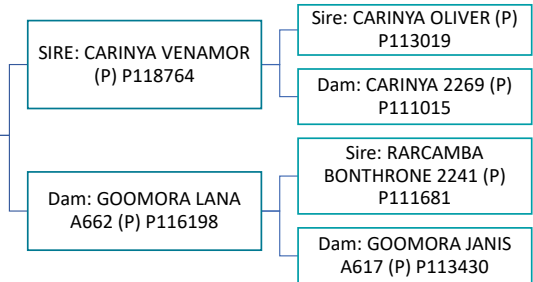





**TRIPLE S**  
BRAFORDS



# PROGRESSIVE GENETICS

- › Selling annually at the National Braford Sale › Private sales available
- › On-property inspections welcome › Female history available

**CLAYTON & SAMANTHA MOGER**

📍 'Weowner', CAPELLA QLD 4723

☎ 0427 170 519

✉ [triplesbraford@gmail.com](mailto:triplesbraford@gmail.com)

📱 [triplesbraford](https://www.facebook.com/triplesbraford)



**TRUTH** *designs*  
*Doing the Journey Together*

**DESIGN**  
**PRINTING**  
**SIGNAGE**  
**WEBSITES**

*Contact Amanda*

Email: [info@truthdesigns.com.au](mailto:info@truthdesigns.com.au)

[www.truthdesigns.com.au](http://www.truthdesigns.com.au)



*Banyula Braford's*



Rhonda Ryan, "Banyula",  
Lilyvale Rd, Emerald Qld 4720  
Email: [banyula02@bigpond.com](mailto:banyula02@bigpond.com)  
Mobile: 0429 631 390

*Quietly Breeding Quality*

# COMMERCIAL heifers

**Lots 43-47**

*All animals have been pre-treated for ticks*



# Lot 43 ABERNETHY 3/20 (P) COMMERCIAL



**NOTES:** Pompes and Pesti Virus free. Genomic tested. Sire verified. Gene tested HPC. Tenderness 7. Dam has 5 calves from 5 joins.

*Pedigree*

**DOB:** DEC 2022

**BRAND:** SCRIPT A UNDER HALF MOON DOT

### Vaccinations

- 3-day sickness
- 5 in 1
- 7 in 1
- 3 Germ Blood

Abernethy C/20

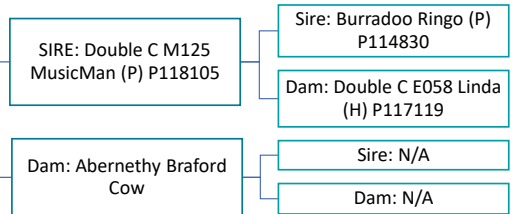

**Purchaser:**

\$

# Lot 44 ABERNETHY 3/19 (P) COMMERCIAL



**NOTES:** Pompes and Pesti Virus free. Genomic tested. Sire verified. Gene tested HPc. Tenderness 5. Kept a bull by this dam and sold privately.

*Pedigree*

**DOB:** DEC 2022

**BRAND:** SCRIPT A UNDER HALF MOON DOT

*Vaccinations*

- 3-day sickness
- 5 in 1
- 7 in 1
- 3 Germ Blood

Abernethy C/16

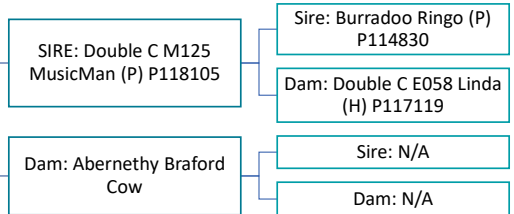

# Lot 45 ABERNETHY 3/16 (P) COMMERCIAL



**NOTES:** Pompes and Pesti Virus free. Genomic tested. Sire verified. Gene tested HPc. Tenderness 4. Dam has had 5 calves from 5 joins.

**DOB:** DEC 2022

**BRAND:** SCRIPT A UNDER  
HALF MOON DOT

## Vaccinations

- 3-day sickness
- 5 in 1
- 7 in 1
- 3 Germ Blood

*Pedigree*

Abernethy 3/16

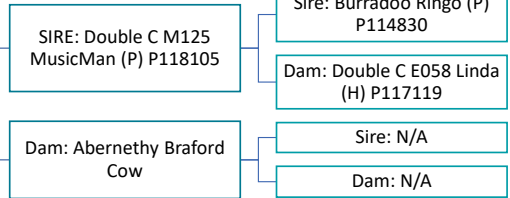

**Purchaser:**

\$

# Lot 46 CALLAWAY M222 TINA (P) COMMERICAL



**NOTES:** Pompes free. Homozygous Poll.

**DOB:** 31/05/2023

**BRAND:** 7PS

## Vaccinations

- 3-day sickness
- 5 in 1
- 7 in 1
- 3 Germ Blood

*Pedigree*

Callaway M222 Tina (PP)

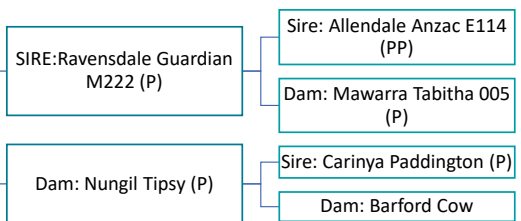



# Lot 47 BANYULA BUBBLE (S) COMMERCIAL



**NOTES:** Pompes free. Sire verified. Gene tested HPc (polled/scurred). A heifer's first calf. Quiet. Serviced by Strathgyle Jimmy on 01/01/24, due on or about 10/10/24. Preg test results at sale.

**DOB:** 26/10/2022

**BRAND:** SCRIPT B  
OVER SCROLL DOT

## Vaccinations

- 3-day sickness
- 5 in 1
- 7 in 1
- 3 Germ Blood

*Pedigree*

BANYULA BUBBLE

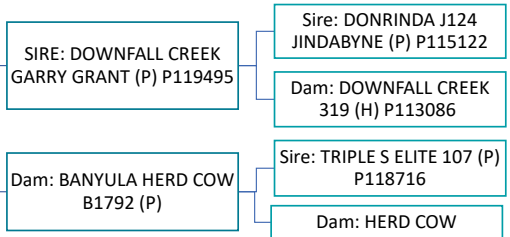

**Purchaser:**

\$

# TERMS & CONDITIONS OF SALE

**GST CLAUSE:** The auction shall be conducted on the basis that the bid price shall be exclusive of GST. GST shall be added after the fall of the hammer for those sales subject to GST.

All bids shall be treated as offers made upon the following Terms and Conditions of Sale and all persons present are admitted to attend the sale on the basis that they have notice of these Terms and Conditions.

1. The highest bidder shall, subject to Condition 2, be the purchaser provided that the vendor reserves the right to bid either by himself or through his agent or auctioneer and should any dispute arise among the bidders for any lot, during or immediately after sale of the lot, it shall be settled at the auctioneers absolute discretion who may, should one of the disputants advance, put the lot or lots up again. The bidding from time to time shall be regulated by the auctioneer and no bid shall be retracted.
2. The sale will be conducted on a "Sale" or "No Sale" basis whereby the lot for sale shall be knocked down to the highest bidder, but the sale will be subject to the acceptance of the highest bid by the vendors who will immediately after the fall of the hammer declare "Sale" or "No Sale". Should the vendor reject the bid of the highest bidder such bidder will have the right of first refusal of the lot at the vendor's nominated price for one hour after the lot has been passed out of the ring on the Terms and Conditions herein set forth in so far as they shall apply.
3. The details of the purchaser, the purchase price and the lot sold as recorded by the sale clerk for and on behalf of the auctioneer shall be equally binding on both purchaser and vendor.
4. The auctioneer expressly reserves the right, without giving any reason therefore, to:-
  - (a) Refuse to acknowledge any bid;
  - (b) Withdraw any lot or lots before or during the sale;
  - (c) Exclude any person from the auction venue should it think fit.
5. Each lot in all cases shall be at the risk and expense of the purchaser, upon acceptance of his bid by the vendor or upon acceptance of the highest bidder's offer by the vendor whichever shall be the earlier.

6. Except as expressly provided in these Terms and Conditions of Sale no guarantee or warranty shall be given in respect of any lot sold under these Conditions as to pedigree, sex, age, breeding condition or otherwise howsoever, and no guarantee, warranty or condition whatsoever shall be implied from any affirmation made before or at the time of the sale, or from any circumstances of the sale, but in all cases where a guarantee is intended the same shall attach and be enforceable only if reduced to writing before delivery of the lot and signed by the vendor or by the auctioneer acting as agent for the vendor, and the absence of such writing shall be conclusive evidence in case of dispute that no guarantee warranty or condition whatsoever was given or implied.
7. In the event of any dispute in respect to the sale of any lot:-
  - (i) The purchaser shall nevertheless be obliged to pay to the auctioneer the full purchase price and any other moneys or interest payable by the purchaser in accordance with these terms and conditions;
  - (ii) The vendor and the purchaser shall resolve the dispute between themselves;
  - (iii) The auctioneer shall have no liability or responsibility in regard to the dispute; and
  - (iv) No lot shall be returned to the auctioneer and the purchaser shall indemnify the auctioneer for all costs, expenses & damages which the auctioneer is put to or incurs by reason of the purchaser so doing.
8. The name of the vendor for whom the auctioneer acts is acknowledged to have been furnished to purchasers prior to sale and further particulars will in all cases be furnished to a purchaser if required. In the case of any dispute the remedy of the purchaser shall be against the vendor only and in no case or under any circumstances against the auctioneer who is to be regarded for all intents and purposes as agent for a disclosed principal.
9. (a) **PAYMENT** - Unless prior credit arrangements have been made in writing with the auctioneer the full purchase price for each lot shall be due and payable to the auctioneer in cash upon acceptance of the highest bid or the highest bidder's offer by the vendor and prior to delivery. Notwithstanding that delivery is given to or possession obtained by the purchaser or his representative prior to the payment of the purchase money in full the property in any lot which is sold shall not pass to the purchaser until the full purchase price and all cheques, promissory notes, bills of exchange, acceptance orders or drafts given in connection with such payment have been paid and liquidated, and

until property shall pass, the purchaser shall hold such lot as bailee, provided that in all cases should such payment not have been made and liquidated within 14 days of the date of the sale the auctioneer reserves the right to:-

(i) Rescind the contract on behalf of the vendor and repossess and resell any lot;

(ii) Recover from the purchaser interest upon the purchase price at a rate per annum which aggregates the 90 day Bill Rate plus two percent. For the purposes of this condition "the 90 day Bill Rate" is the rate published regularly in the Australian Financial Review, expressed as a percentage per annum. If at any time the Financial Review ceases to publish a 90 day Bill Rate, the auctioneer shall determine and advise the purchaser of the interest rate to apply for the purpose of this condition.

9. (b) The auctioneer is selling as the delcredere agent of the vendor and the full purchase price of any lot sold shall be payable by the purchaser to the auctioneer and be fully recoverable by the auctioneer in its own name.
10. If the purchaser shall neglect or fail to comply with any of the within conditions, any lot purchased by him may be immediately resold by public auction or private contract, with or without notice, at the risk of the former purchaser, who will be held responsible for all loss and expenses arising out of such resale, and shall not participate in any profit accruing there from.
11. Any vendor or purchaser removing the sale number from any lot after it has been sold will fully indemnify all affected parties for any loss, costs or damage should the lot be wrongly delivered.
12. The purchasers, if more than one, shall be jointly and severally bound by these Terms and Conditions, and shall jointly and severally carry out and perform same.
13. Any person who advances a bid on a lot shall do so on the expressed condition and understanding that should that person's bid be the highest bid and such bid is accepted by the vendor, then that person will be held personally liable for the price so agreed upon, regardless of the fact that that person may be acting on behalf of another party, either disclosed or undisclosed to the vendor or the auctioneer, provided however, that this Condition shall not in any way negate the vendor's right to claim against any principal and in such case the bidder's liability shall be construed to be by way of guarantee.



14. The auctioneer may should it think fit, make arrangements on a purchaser's behalf for the feeding, watering, trucking, shipping of and general attendance to any lot after sale but no responsibility will be accepted by the auctioneer and all such service shall be at the purchaser's risk and expense.
15. No lot will be delivered until the sales invoice has been checked and signed by the purchaser or his duly authorised representative.
16. (a) Each lot in all cases shall be sold with all faults, if any, and excepting those conditions and warranties implied by the Trade Practices Act or any applicable State legislation which cannot be contractually excluded and excepting conditions and warranties expressly contained in these Terms and Conditions of Sale, any express or implied condition, statement or warranty, statutory or otherwise, is hereby excluded. The auctioneer is not liable in respect of any error, misdescription or omission in any particulars appearing or stated regarding the descriptions or pedigrees of any lot offered for sale and no such error, misdescription or omission shall entitle the purchaser to annul the sale or reject the lot or claim any compensation, damage or abatement in price.  
  
(b) Each lot will be sold subject to passing all veterinary tests required by the law of the State or country to which the purchaser intends to transport that particular lot, such tests to be undertaken at the purchaser's expense and concluded immediately following the sale. In the event of a lot failing to pass these tests, the sale shall be null and void, any purchase moneys paid by the purchaser shall be refunded and property in the lot shall revert to or remain with the vendor.
17. GUARANTEES OF FERTILITY:-
  - 17.1 BULLS. Save and except for calves at foot, all bulls are guaranteed breeders and to so prove within 6 months of the date of sale or by reaching the age of 24 months whichever date be the later.
  - 17.2 FEMALES. Save and except for female calves at foot, all females are guaranteed to be in calf or go into calf within six months of the date of sale or by the age of 30 months whichever date shall be the later. A positive pregnancy test certified by a qualified veterinary surgeon shall be sufficient evidence that the animal is in calf.
  - 17.3 Claims under Clauses 17.1 and 17.2 guarantees of fertility shall be made to the vendor within six months from the date of sale or prior to the animal entering a quarantine area other than on the vendor's property.

17.3.1 All claims must be accompanied by a veterinary certificate issued by a registered veterinarian in accordance with the guidelines established by the Aust Association of Cattle Veterinarians which shall clearly identify the basis of the claim.

17.3.2 Infertility resulting from injury or disease occurring after the sale shall not be covered by this guarantee.

17.3.3 The vendor retains the right to have the animal placed on a property nominated by him or returned to his own property for further assessment of fertility for a period not exceeding six months. In the event of the animal being proven fertile within the period such status shall be confirmed by a certificate issued by a registered veterinarian in accordance with the guidelines established by the Australian Association of Cattle Veterinarians and costs incurred shall be borne by the purchaser. In the event of the animal not being proven fertile within the period the costs incurred shall be borne by the vendor.

17.4 LIABILITY OF A VENDOR. Except for costs defined elsewhere in the conditions of sale, the liability of a vendor in respect of claims relating to fertility shall not exceed the purchase price of the animal(s) or to provide mutually agreed upon replacement animals.

17.5 REFUNDS. In the event of a claim being substantiated and the purchase price being refunded, the animal/s shall automatically become the property of the vendor and be returned to him or disposed of according to his instructions at his expense.

17.6 This guarantee shall be voided by the purchaser if-

(a) The animal is returned to the vendor -

(i) in poor physical condition or with any injury;

(ii) tests carried out on behalf of the vendor within fourteen days of such return proved positive to any diseases which may affect the animals fertility or ability to breed naturally; or

(b) the purchaser has collected and stored semen from a bull or embryos from a female.

17.7 In the event of a dispute as to whether a lot is a breeder, such dispute shall be resolved by the vendor and the purchaser and the auctioneer, while he will use his best endeavours to assist, shall have no liability or responsibility in that regard. In the event that a lot is alleged or proved not to be a breeder, the purchaser shall nevertheless be obliged to pay the auctioneer the full purchase price and any other monies or

interest payable by the purchaser in accordance with these Terms and Conditions.

18. (a) Each lot shall be at the risk of the vendor in respect of any damage or injury, whether by disease, accident or otherwise, for the period that the lot be in the custody of the auctioneer, PROVIDED THAT the auctioneer, its servants, agents and employees shall use all reasonable care to protect and control the lot while it is in the auctioneer's custody AND PROVIDED THAT when a lot has been sold, it shall be at the risk of the purchaser in all respects.

(b) If any vendor brings to the sale premises any lot which is dangerous, or infected with any disease, that vendor shall be liable for all injury, damages, costs, losses, or expenses which the auctioneer may sustain, incur or be put to either directly or indirectly as a result of the vendor so doing. The auctioneer reserves the right, at its absolute discretion, to exclude from the sale, or put out of the sale venue or dispose of, any lot which in its opinion shows signs of any disease, whether infectious, contagious or not, or of any serious fault or of being dangerous.

19. DELIVERY - Except at the discretion of the auctioneer no lot shall be delivered to the purchaser unless payment of the purchase money together with any additional charges incurred including those expenses incurred by the auctioneer pursuant to Condition 14 hereof, is first made by the purchaser to the auctioneer. Release of lots may be withheld by the auctioneer until personal cheques are cleared.

20. In these Conditions:-

(a) References to "Auctioneer" shall be taken to mean as the context so admits, the selling agent or any member, subsidiary or related corporation or body, officer, agent or employee thereof, authorised by the vendor to conduct the sale of the lot;

(b) "Purchaser" shall have the meaning ascribed to it in Condition 1;

(c) "Vendor" shall mean the person or corporation upon whose account lots are offered for sale and where a stud or farm is named shall mean the proprietor of that stud or farm;

(d) "Lot" shall be taken to mean the animal offered for sale and/or sold by the auctioneer on behalf of a vendor.

\* \* \* \* \*

## **IMPORTANT NOTICE**

The Selling Agent, its members, subsidiary or related corporations, officers, agents, and employees for themselves and for those for whom they act, while exercising due care, provide all information without responsibility and give no guarantee whatsoever as to its accuracy.

All persons who attend the Sale do so entirely at their risk and the Selling Agent, its members, subsidiary or related corporations, officers, agents, employees and its principals, for themselves and for those for whom they act, do not assume or accept any responsibility or liability of whatever nature for any injury or damage whatsoever which may occur.

The Australian Braford Society Inc, whilst taking all care and attention with the presentation of data does not guarantee or certify the accuracy of the data or the suitability for use of any lot. Buyers should verify the accuracy and suitability of data with the vendor or the vendors agent.

\* \* \* \* \*



# Wide Bay Burnett Braford Group Heifer Sale

## BUYER INSTRUCTION SLIP

NO VERBAL INSTRUCTIONS ACCEPTED

Name: \_\_\_\_\_ Bid Card No: \_\_\_\_\_

Address: \_\_\_\_\_

\_\_\_\_\_

Mobile: \_\_\_\_\_ Buyers PIC: \_\_\_\_\_

Email: \_\_\_\_\_

### DETAILS OF LOTS PURCHASED OVERLEAF

*Payment Method* (please tick)  Cheque/EFT or  Account 

Account to: \_\_\_\_\_

*(only if prior arrangement has been made - Letter of Introduction from Agent)*

*Insurance Required* (please tick)  Yes or  No

Period of Insurance Required: \_\_\_\_\_

*Transport* (please tick)  Own or  Other

If other, transport name: \_\_\_\_\_

*NOTE: Transportation/agistment arranged by purchasers with vendors is done so at the purchaser's risk. No responsibility will be accepted by vendors for any damage, loss or injury.*

*Other Instructions* \_\_\_\_\_

\_\_\_\_\_

\_\_\_\_\_

\_\_\_\_\_

Buyers Signature: \_\_\_\_\_ Date: \_\_\_\_\_

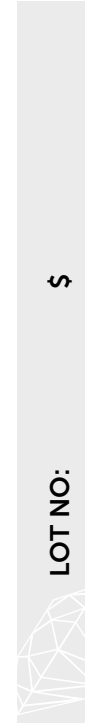
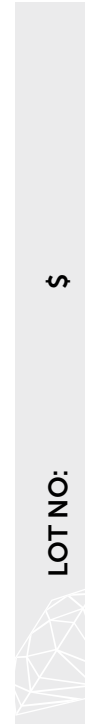
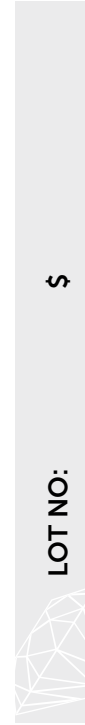
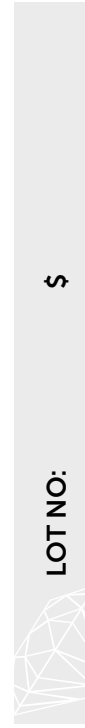
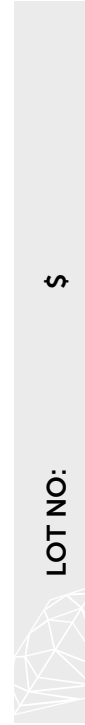
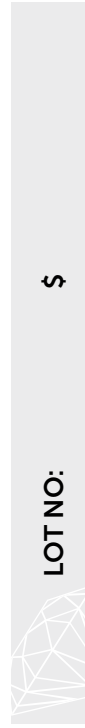
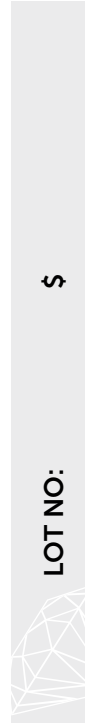
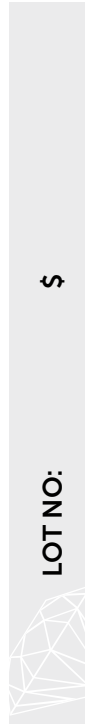
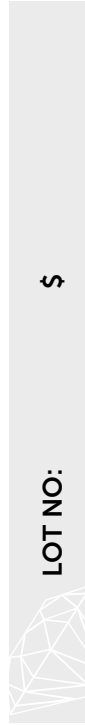
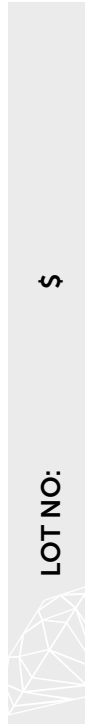
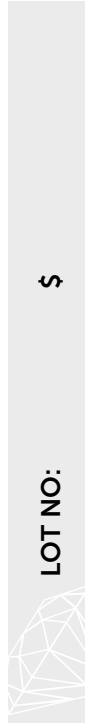
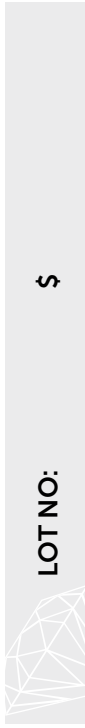
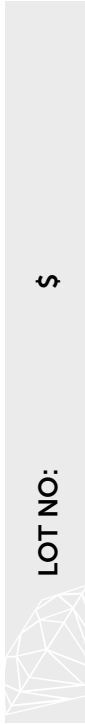
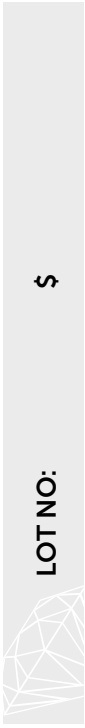
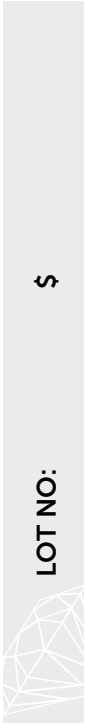

Thank you for your support of the  
**Wide Bay Burnett**

*Braford Group*



**HEIFER SALE**

**23 March 2024**

# Wide Bay Burnett Braford Group

*Thank you to our sponsors!*

## **Gold Sponsors**

Norco Gayndah - Jordan Family  
Rabobank Australia - Peter Treasure - Bundaberg  
Riverina - Adam Shailer - Murgon

## **Silver Sponsors**

Virbac Multimin - Adreanna Pott - Mundubbera  
Triple S Braford's - Claton and Sam Moger  
Monto Vet Services - Stacey Rae  
GDL - Mark Duthie

## **Bronze Sponsors**

Banyula Braford Stud - Rhonda Ryan  
Zarabella Art Gallery - Zara Bambling  
Truth Designs - Amanda Woodward

*Special thanks to...*

**GDL Rural** - our auctioneers today!

*and*

**Truth Designs** - for this great catalogue design!

*Lucky Purchaser Lot drawn at the end of the sale will  
receive two prints and card pack from Zarabellas Art Gallery*

**Zarabella Art Gallery - Zara Bambling - 0456 428 002**

